

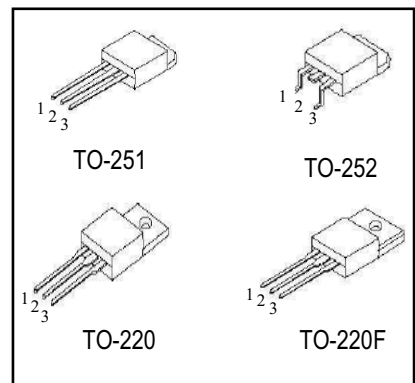
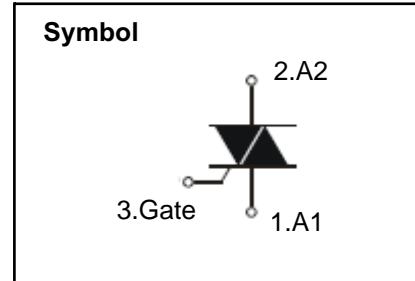
## 4A TRIACS

### Features

- ◆ Repetitive Peak Off-State Voltage : 600V-800V
- ◆ R.M.S On-State Current (  $I_{T(RMS)} = 4\text{ A}$  )
- ◆ High Commutation  $dv/dt$
- ◆ Sensitive Gate Triggering 3 Mode ( $I_{GT} = 5\text{ to }35\text{mA}$ )
- ◆ Non-isolated Type

### General Description

This device is sensitive gate triac suitable for direct coupling to TTL, HTL, CMOS and application such as various logic functions, low power AC switching applications, such as fan speed, small light controllers and home appliance equipment.



### Absolute Maximum Ratings ( $T_J = 25^\circ\text{C}$ unless otherwise specified )

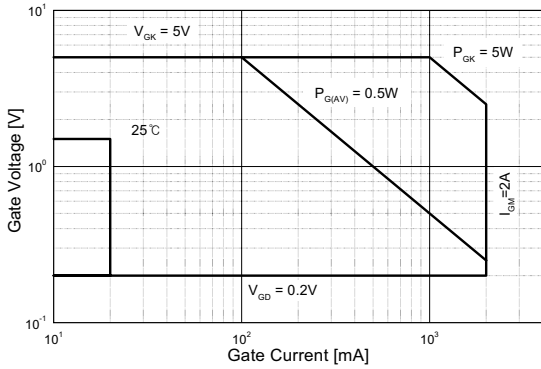
Symbol	Parameter	Condition	Ratings	Units
$V_{DRM}$	Repetitive Peak Off-State Voltage		600-800	V
$I_{T(RMS)}$	R.M.S On-State Current	$T_C = 107^\circ\text{C}$	4	A
$I_{TSM}$	Surge On-State Current	One Cycle, 50Hz/60Hz, Peak, Non-Repetitive	30/31	A
$I^2t$	$I^2t$ for Fusing	$t = 10\text{ms}$	5.1	$\text{A}^2\text{s}$
$P_{GM}$	Peak Gate Power Dissipation		5	W
$P_{G(AV)}$	Average Gate Power Dissipation	Over any 20ms period	0.5	W
$I_{GM}$	Peak Gate Current		2	A
$V_{GM}$	Peak Gate Voltage		5	V
$T_J$	Operating Junction Temperature		- 40 ~ 125	$^\circ\text{C}$
$T_{STG}$	Storage Temperature		- 40 ~ 150	$^\circ\text{C}$
$di/dt$	Critical Rate Of Rise Of On-State Current $I_G = 2 \times I_{GT}, t_r \leq 100\text{ns}$	$F = 120\text{Hz}, T_J = 125^\circ\text{C}$	50	A/ $\mu\text{s}$

# BPT4 Series

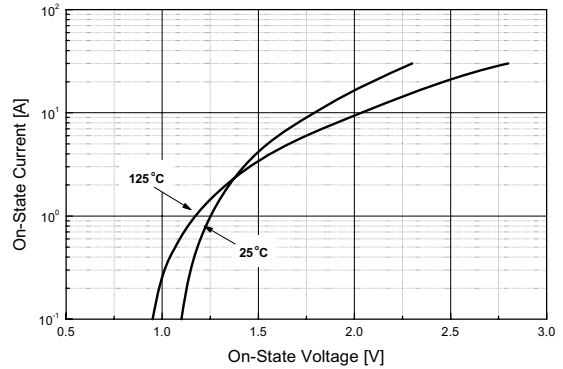
## Electrical Characteristics

Symbol	Items		Conditions	BPT4			Unit	
				BPT405	BPT410	BPT435		
$I_{DRM}$	Repetitive Peak Off-State Current		$V_D = V_{DRM}$ , Single Phase, Half Wave $T_J = 125\text{ }^\circ\text{C}$	MAX.	1	1	1	mA
$V_{TM}$	Peak On-State Voltage		$I_T = 5\text{ A}$ , Inst. Measurement	MAX.	1.56	1.56	1.56	V
$I_{GT1}^+$	I	Gate Trigger Current	$V_D = 12\text{ V}$ , $R_L = 30\ \Omega$	MAX.	5	10	35	mA
$I_{GT1}^-$	II			MAX.	5	10	35	
$I_{GT3}^-$	III			MAX.	5	10	35	
$I_{GT3}^+$	IV			MAX.	5	10	35	
$V_{GT1}^+$	I	Gate Trigger Voltage	$V_D = 12\text{ V}$ , $R_L = 30\ \Omega$	MAX.	1.3	1.3	1.3	V
$V_{GT1}^-$	II			MAX.	1.3	1.3	1.3	
$V_{GT3}^-$	III			MAX.	1.3	1.3	1.3	
$V_{GT3}^+$	IV			MAX.	1.3	1.3	1.3	
$V_{GD}$	Non-Trigger Gate Voltage		$T_J = 125\text{ }^\circ\text{C}$ , $V_D = 1/2 V_{DRM}$	MIN.	0.2	0.2	0.2	V
dv/dt	Critical Rate of Rise Off-State Voltage at Commutation		$V_D = 2/3 V_{DRM}$ gata open $T_J = 125\text{ }^\circ\text{C}$	MIN.	20	40	400	V/ $\mu\text{s}$
$I_H$	Holding Current			MAX.	10	15	35	mA
$R_{th(j-c)}$	Thermal Impedance		Junction to case	MAX.	3.0	3.0	3.0	$^\circ\text{C/W}$
(dv/dt) <sub>c</sub>	(dv/dt) <sub>c</sub> = 0.1V/ $\mu\text{s}$ , $T_J = 125\text{ }^\circ\text{C}$ ,			MIN.	1.9	2.7	—	A/ms
	(dv/dt) <sub>c</sub> = 10V/ $\mu\text{s}$ , $T_J = 125\text{ }^\circ\text{C}$ ,				1.0	2.0	—	
	Without snubber $T_J = 125\text{ }^\circ\text{C}$ ,				—	—	2.5	

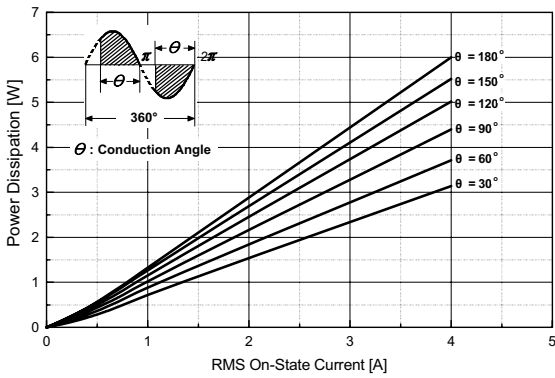
**Fig 1. Gate Characteristics**



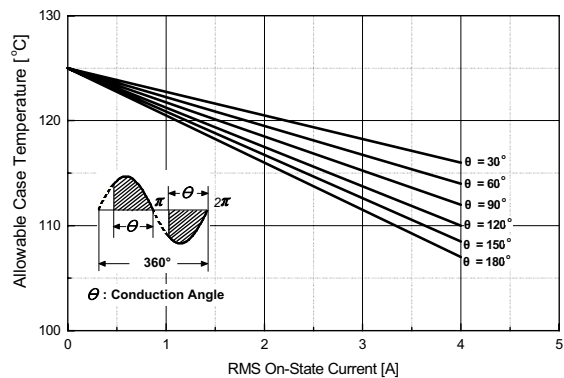
**Fig 2. On-State Voltage**



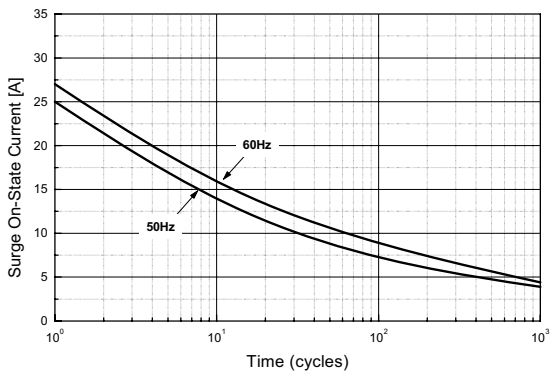
**Fig 3. On State Current vs. Maximum Power Dissipation**



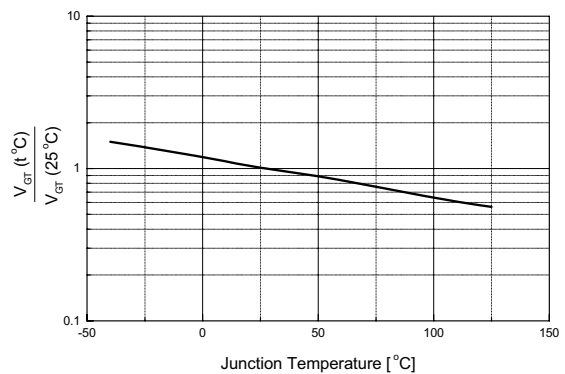
**Fig 4. On State Current vs. Allowable Case Temperature**



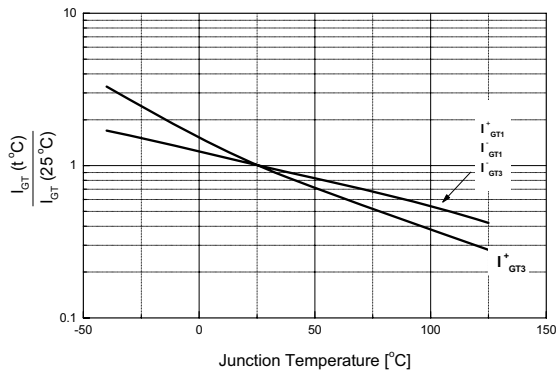
**Fig 5. Surge On-State Current Rating ( Non-Repetitive )**



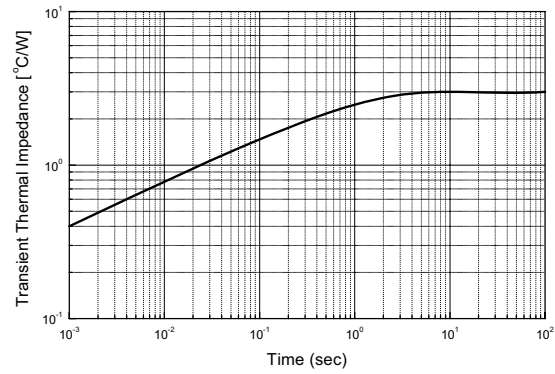
**Fig 6. Gate Trigger Voltage vs. Junction Temperature**



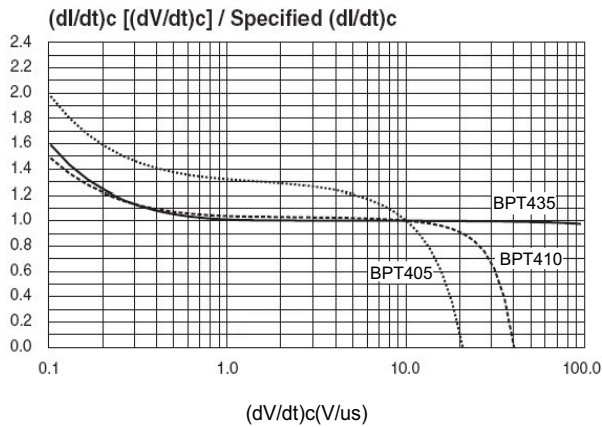
**Fig 7. Gate Trigger Current vs. Junction Temperature**



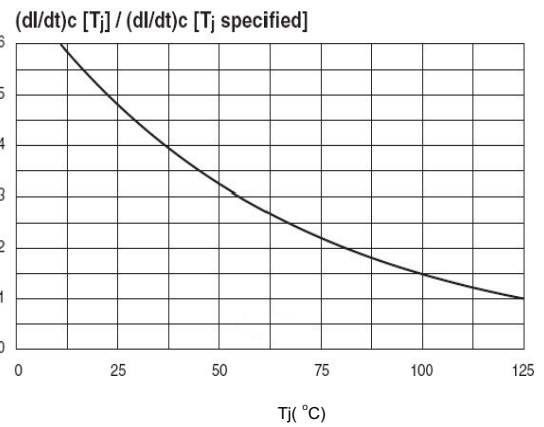
**Fig 8. Transient Thermal Impedance**



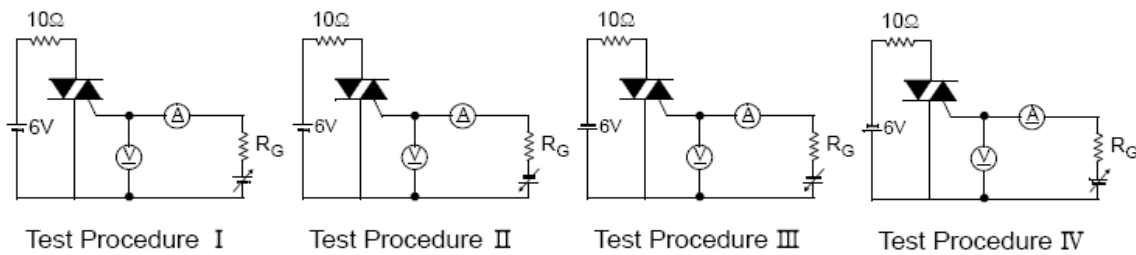
**Fig9. Relative Variation Of Critical Rate Of Decrease Of Main Current Versus (dv/dt)c (Typical Values)**



**Fig10. Relative Variation Of Critical Rate Of Decrease Of Main Current Versus Junction Temperature**

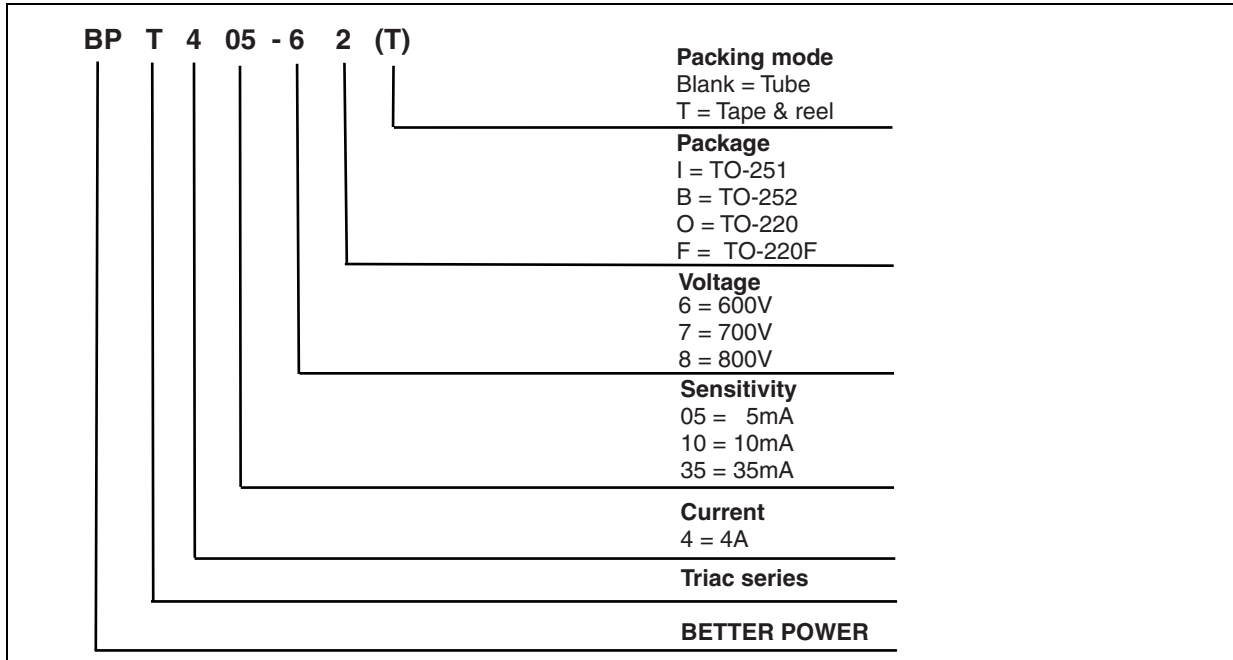


**Fig 11. Gate Trigger Characteristics Test Circuit**



# BPT4 Series

## Ordering Information Scheme



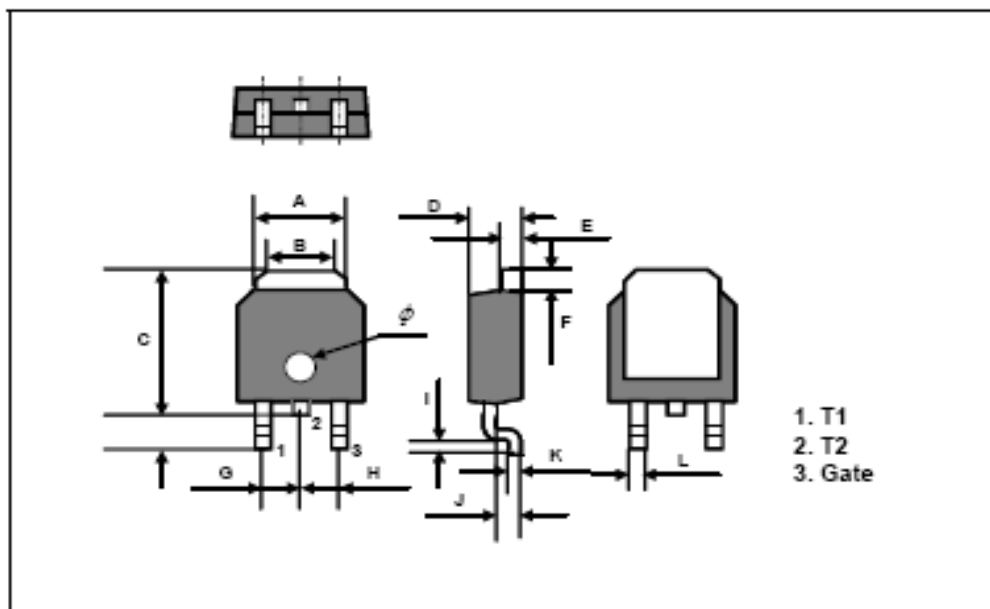
## Product Selector

Part Number	Voltage (xxx)			Sensitivity	Type	Package
	600 V	700 V	800 V			
BPT405-xB	X	X	X	5 mA	Logic level	TO-252
BPT405-xI	X	X	X	5 mA	Logic level	TO-251
BPT405-xO	X	X	X	5 mA	Logic level	TO-220
BPT405-xF	X	X	X	5 mA	Logic level	TO-220F
BPT410-xB	X	X	X	10 mA	Logic level	TO-252
BPT410-xI	X	X	X	10 mA	Logic Level	TO-251
BPT410-xO	X	X	X	10 mA	Logic Level	TO-220
BPT410-xF	X	X	X	10 mA	Logic Level	TO-220F
BPT435-xB	X	X	X	35 mA	Snubberless	TO-252
BPT435-xI	X	X	X	35 mA	Snubberless	TO-251
BPT435-xO	X	X	X	35 mA	Snubberless	TO-220
BPT435-xF	X	X	X	35 mA	Snubberless	TO-220F

# BPT4 Series

## TO-252(D-PAK) Package Dimension

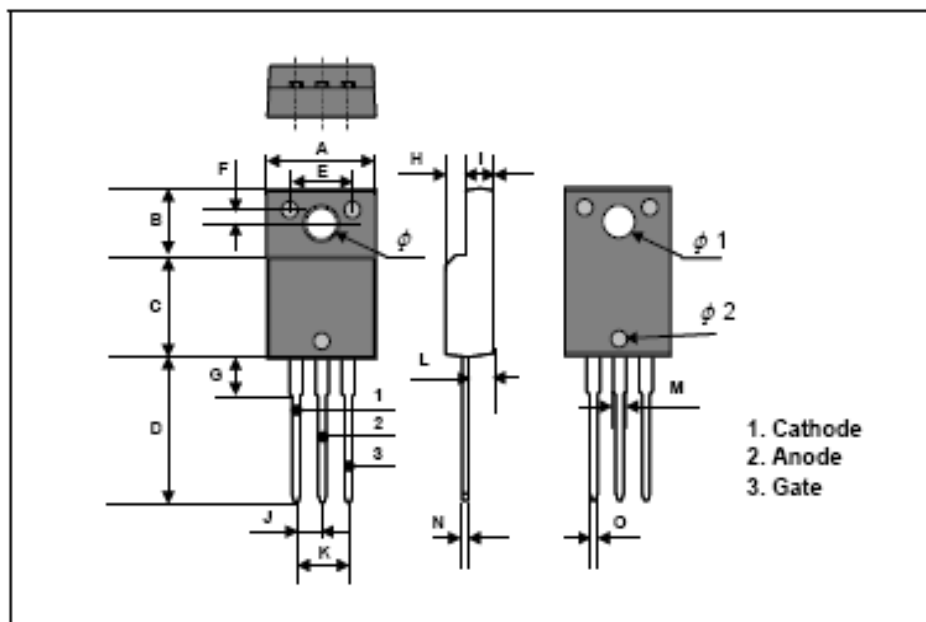
Dim.	mm			Inch		
	Min.	Typ.	Max.	Min.	Typ.	Max.
A	6.48	6.604	6.73	0.255	0.26	0.265
B	5.0	5.08	5.21	0.197	0.2	0.205
C	7.42	7.8	8.18	0.292	0.307	0.322
D	2.184	2.286	2.388	0.086	0.09	0.094
E	0.762	0.813	0.864	0.03	0.032	0.034
F	1.016	1.067	1.118	0.04	0.042	0.044
G		2.286			0.09	
H		2.286			0.09	
I	0.534	0.61	0.686	0.021	0.024	0.027
J	1.016	1.067	1.118	0.04	0.042	0.044
K		0.508			0.02	
L		0.762			0.03	
$\phi$		1.57			0.06	



# BPT4 Series

## TO-220F Package Dimension

Dim.	mm			Inch		
	Min.	Typ.	Max.	Min.	Typ.	Max.
A	10.4		10.6	0.409		0.417
B	6.18		6.44	0.243		0.254
C	9.55		9.81	0.376		0.386
D	13.47		13.73	0.530		0.540
E	6.05		6.15	0.238		0.242
F	1.26		1.36	0.050		0.054
G	3.17		3.43	0.125		0.135
H	1.87		2.13	0.074		0.084
I	2.57		2.83	0.101		0.111
J		2.54			0.100	
K		5.08			0.200	
L	2.51		2.62	0.099		0.103
M	1.25		1.55	0.049		0.061
N	0.45		0.63	0.018		0.025
O	0.8		1.0	0.024		0.039
$\phi$		3.7			0.146	
$\phi 1$		3.2			0.126	
$\phi 2$		1.5			0.059	



# BPT4 Series

## TO-220 Package Dimension

Dim.	mm			Inch		
	Min.	Typ.	Max.	Min.	Typ.	Max.
A	9.7		10.1	0.382		0.398
B	6.3		6.7	0.248		0.264
C	9.0		9.47	0.354		0.373
D	12.8		13.3	0.504		0.524
E	1.2		1.4	0.047		0.055
F		1.7			0.067	
G		2.5			0.098	
H	3.0		3.4	0.118		0.134
I	1.25		1.4	0.049		0.055
J	2.4		2.7	0.094		0.106
K	5.0		5.15	0.197		0.203
L	2.2		2.6	0.087		0.102
M	1.25		1.55	0.049		0.061
N	0.45		0.6	0.018		0.024
O	0.6		1.0	0.024		0.039
$\phi$		3.6			0.142	

